



**ON Semiconductor®**

# Test Procedure for the NCP1565 3.3-V/20-A Dc-dc Converter



# Board Electrical Schematic

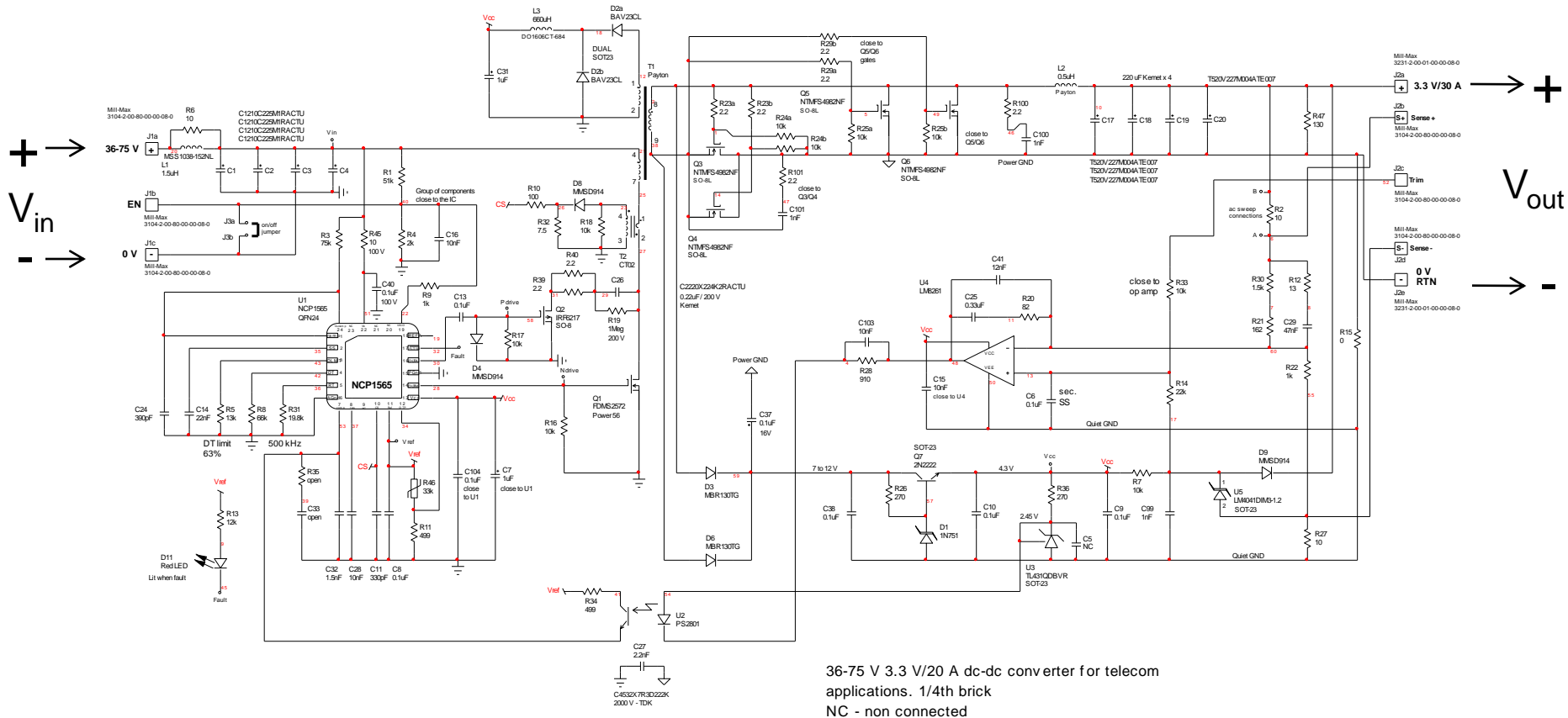

Dc input voltage  
 36 – 72 V

3.3 V/20 A  
 Output voltage



# Board Picture

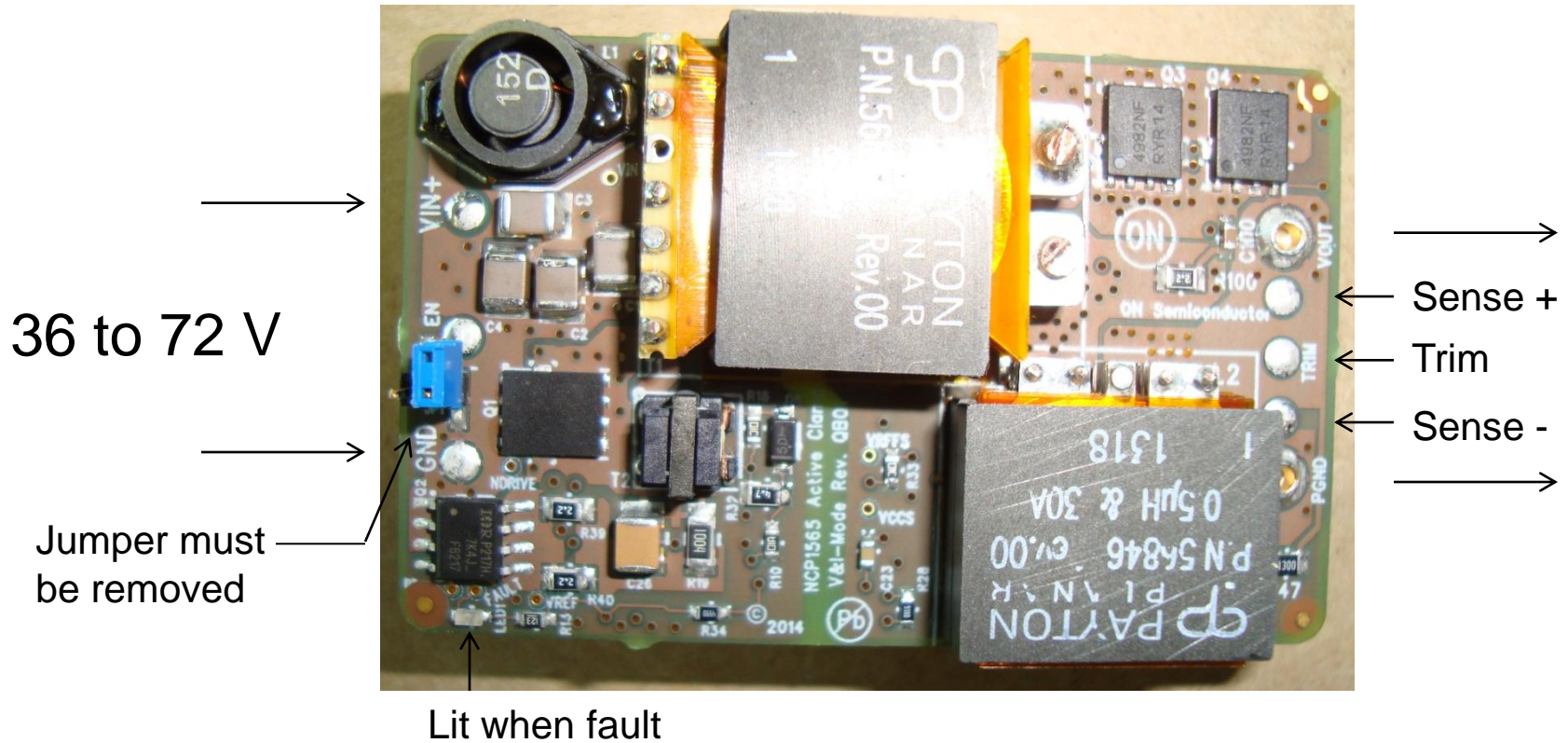

Input voltage from 36 V to 72 V  
dc. Nominal input is 48 V

Output voltage is 3.3 V  
nominal current is 20 A

# Needed Equipment

The needed equipments are the following:

- ❑ a dc voltage source, delivering up to 80 V dc and up to 3 A
- ❑ a dc load absorbing up to 100 W,  $V_{in,max} < 20 \text{ V}$ ,  $I_{out,max} < 40 \text{ A}$
- ❑ either the above load can display dc V and dc A or separated V and A-meters are necessary
- ❑ An oscilloscope with single shot capability
- *Kelvin sensing is necessary to connect the load to the board. If no precautions are taken, it is likely that the voltage drop at the load cables ends induces a reading error*



# Basic Test Setup

source



load

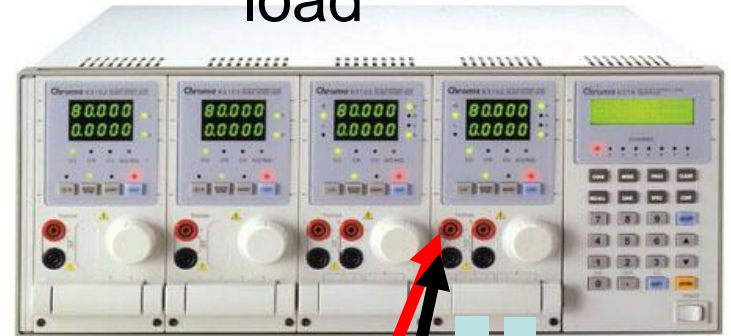

Jumper is removed



Socket in which the dc-dc is firmly plugged

Kelvin sense

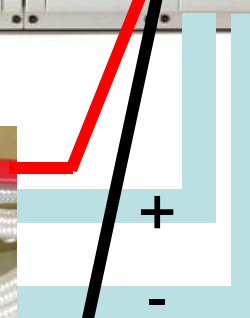

# Test n°1

Source = 36 V



Load = 20 A

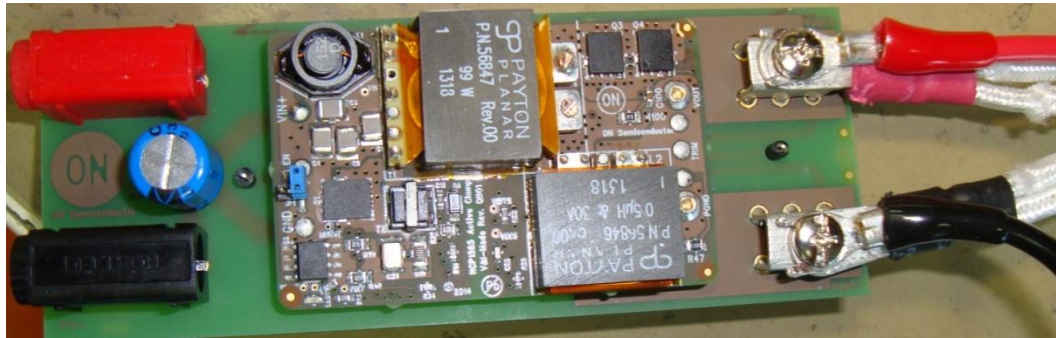
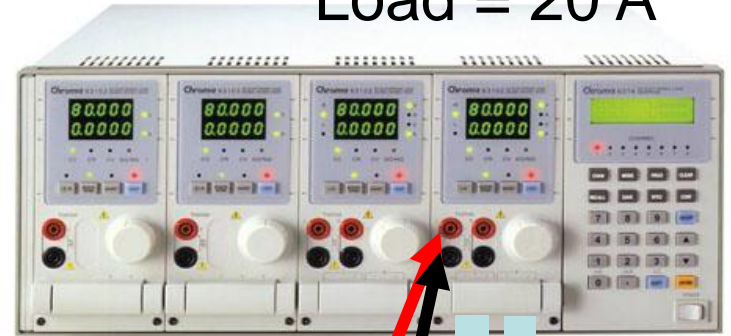

- Start the power supply while the load current is 20 A
- Monitor the output voltage on a scope
- Verify the voltage is monotonically rising



# Test n°1

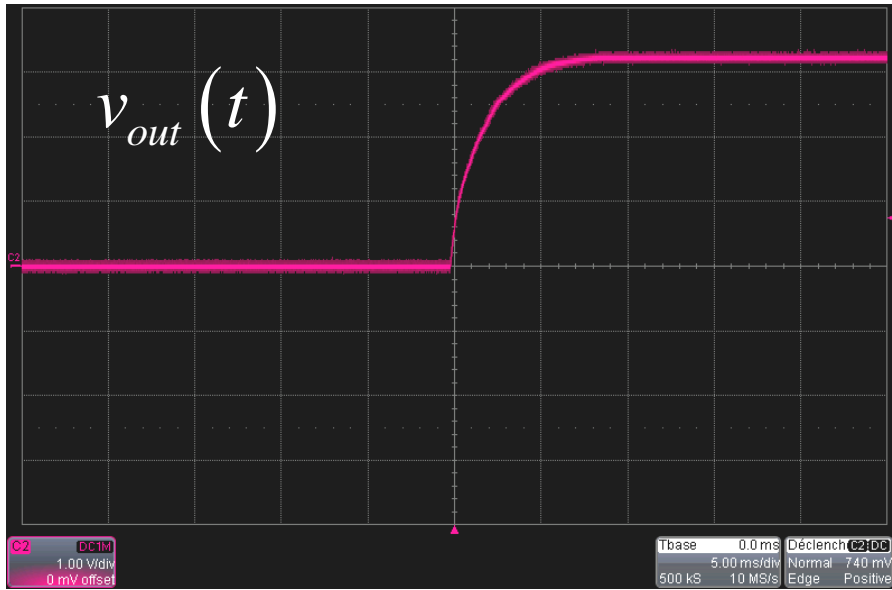

Ok

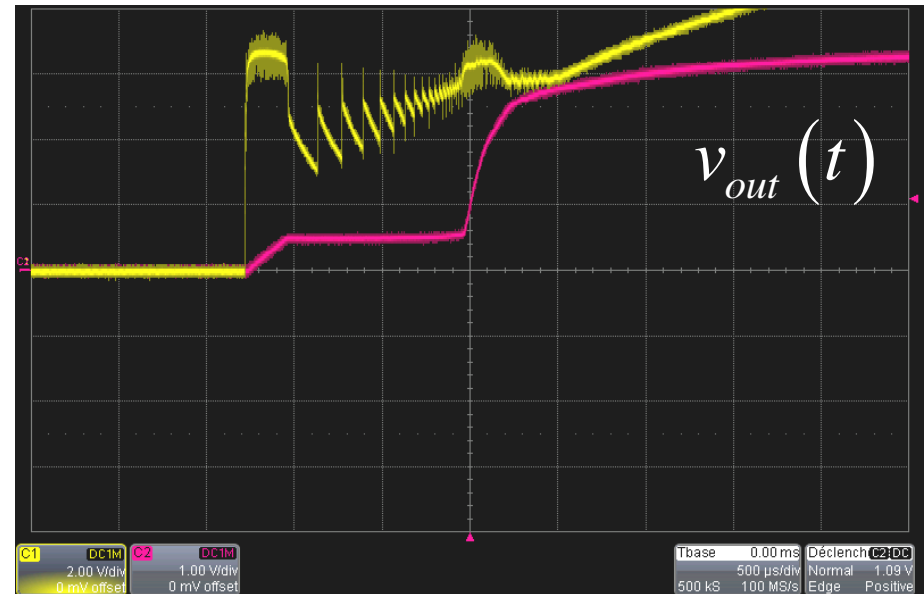

Bad

- It is important to verify the absence of double slope
- Repeat the test for  $V_{in} = 48\text{ V}$  and  $72\text{ V}$
- Change load to  $0\text{ A}$ , repeat tests. Wait  $10\text{ s}$  between re-starts.

# Test n°2

source



load

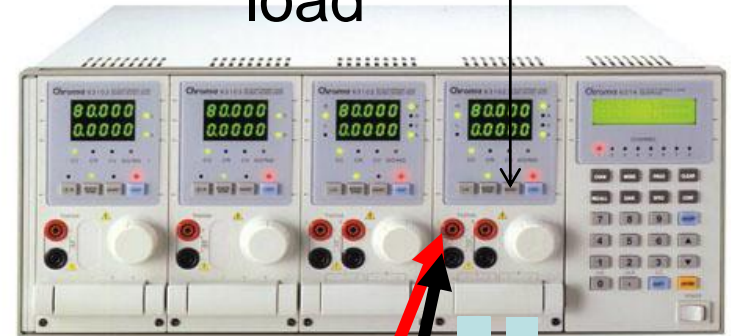

Jumper is removed



- Press short circuit at  $V_{in} = 36\text{ V}$ . Led blinks, board ticks.
- Repeat test for  $V_{in} = 48\text{ V}$  and  $72\text{ V}$
- Release short and make sure output resumes at  $3.3\text{ V}$ .



# Test n°3

source



load

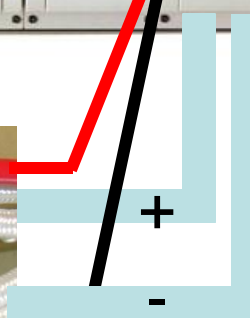
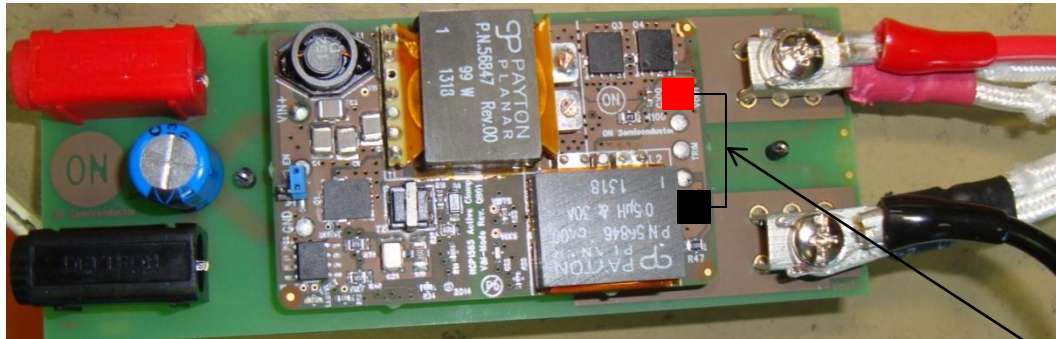
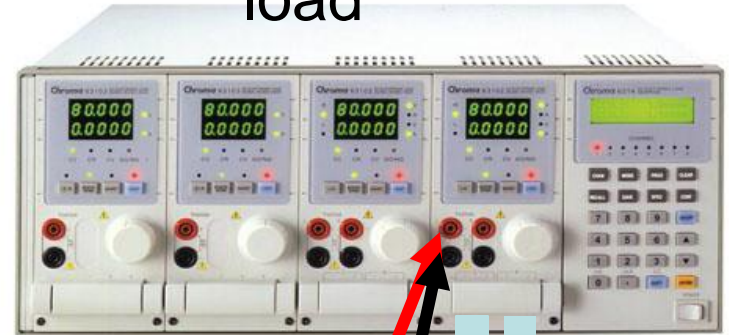

Probe here



No pigtail!

- Program load to dynamic current mode
- $I_{out}$  from 20 A to 15 A, slope 1 A/ $\mu$ s
- 1 ms interval, observe  $V_{out}$  on scope in ac, 20 mV/div



# Test n°3

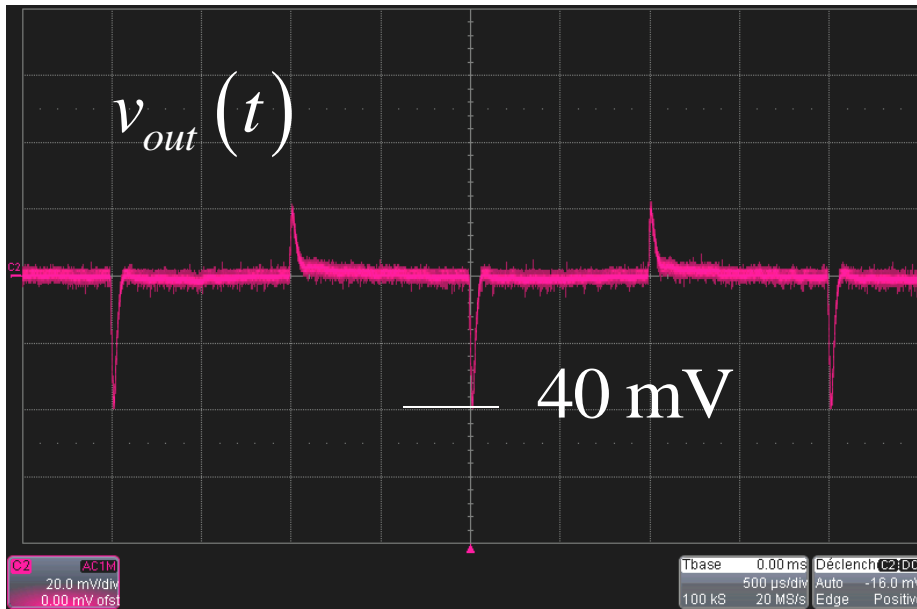

$V_{in} = 36 \text{ V}$   $I_{out} = 15 \text{ to } 20 \text{ A}$ ,  $1 \text{ A}/\mu\text{s}$

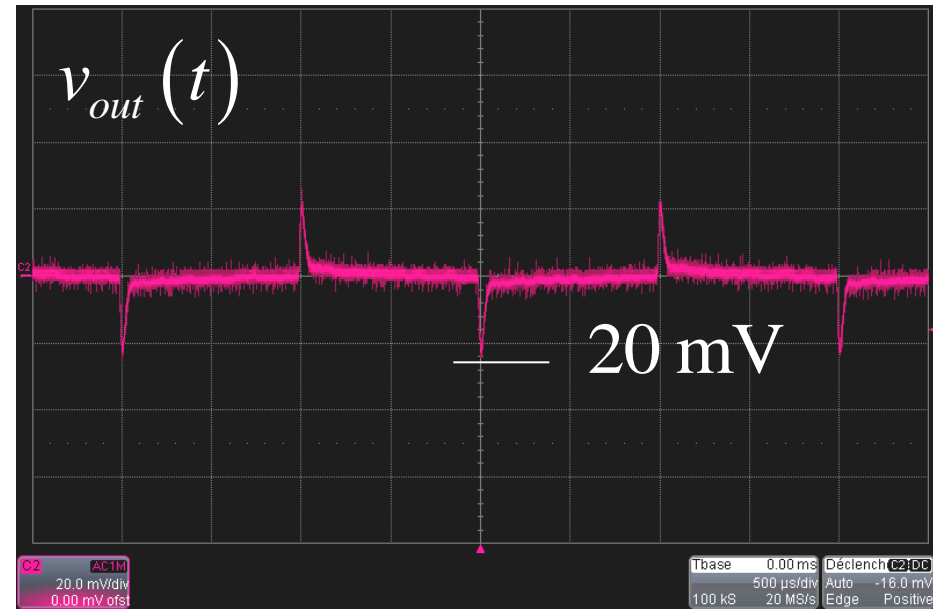

$V_{in} = 48 \text{ V}$   $I_{out} = 15 \text{ to } 20 \text{ A}$ ,  $1 \text{ A}/\mu\text{s}$

- Run the test from  $V_{in} = 36 \text{ V}$  (worst case) to  $V_{in} = 72 \text{ V}$ .
- Spec is to have an under/over shoot less than 60 mV

# Test n°4

source



load

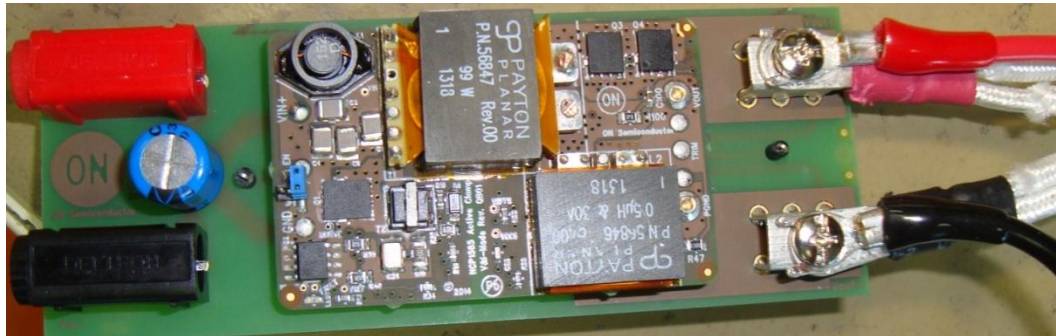
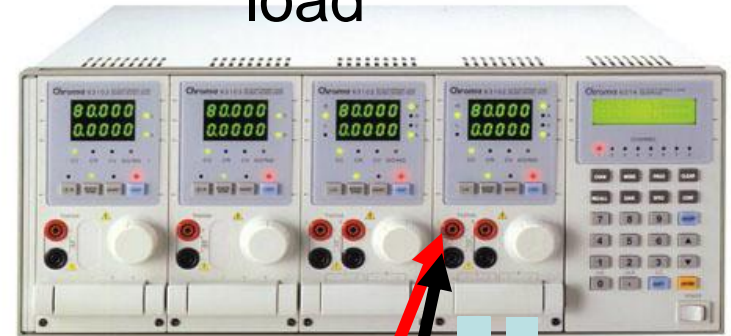

- Leave the board for 5 mn at  $V_{in} = 36 \text{ V}/20 \text{ A}$ .
- Check no thermal disjonction occurs.
- Board is declared sound.