

## GaAs pHEMT MMIC 2 WATT POWER AMPLIFIER 29 - 37 GHz



### Typical Applications

The HMC1029 is ideal for:

- Point-to-Point Radios
- Point-to-Multi-Point Radios
- VSAT & SATCOM
- Military & Space

### Features

- Saturated Output Power: +35 dBm @ 25% PAE
- High Output IP3: +42 dBm
- High Gain: 24 dB
- DC Supply: +6V @ 1400 mA
- No External Matching Required
- Die Size: 2.79 x 2.37 x 0.1 mm

### Functional Diagram [3]

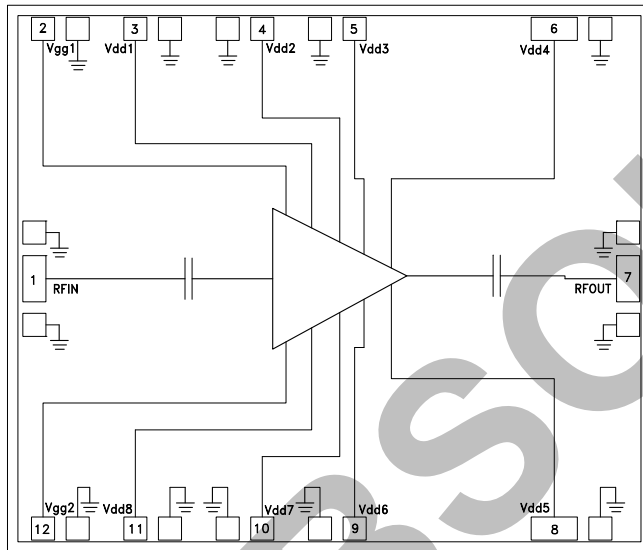

### General Description

The HMC1029 is a four stage GaAs pHEMT MMIC 2 Watt Power Amplifier which operates between 29 and 37 GHz. The HMC1029 provides 24 dB of gain, +35 dBm of saturated output power, and 25% PAE from a +6V power supply. The HMC1029 exhibits excellent linearity and is optimized for high capacity point-to-point and point-to-multi-point radio systems. The amplifier configuration and high gain make it an excellent candidate for last stage signal amplification before the antenna. All data is taken with the chip in a 50 Ohm test fixture connected via (2) 0.025 mm (1 mil) diameter wire bonds of 0.31 mm (12 mil) length.

### Electrical Specifications, $T_A = +25^\circ C$

$V_{dd} = V_{dd1}, V_{dd2}, V_{dd3}, V_{dd4}, V_{dd5}, V_{dd6}, V_{dd7}, V_{dd8} = +6V, I_{dd} = 1400 mA$  [1]

Parameter	Min.	Typ.	Max.	Min.	Typ.	Max.	Units
Frequency Range	29 - 34		34 - 37				GHz
Gain	21	24		19.5	22.5		dB
Gain Variation Over Temperature		0.025			0.03		dB/ °C
Input Return Loss		20			18		dB
Output Return Loss		14			20		dB
Output Power for 1 dB Compression (P1dB)	27	31		27	30.5		dBm
Saturated Output Power (P <sub>sat</sub> )		35			34		dBm
Output Third Order Intercept (IP3) <sup>[2]</sup>		42			40		dBm
Total Supply Current (I <sub>dd</sub> )		1400			1400		mA

[1] Adjust V<sub>gg</sub> between -2 to 0V to achieve I<sub>dd</sub> = 1400 mA typical.

[2] Measurement taken at +6V @ 1400 mA, P<sub>out</sub> / Tone = +24 dBm

[3] V<sub>gg1</sub> and V<sub>gg2</sub> connected internally, amplifier can be biased by either V<sub>gg1</sub> or V<sub>gg2</sub>

**GaAs pHEMT MMIC 2 WATT POWER AMPLIFIER  
29 - 37 GHz**



**Broadband Gain & Return Loss vs. Frequency**

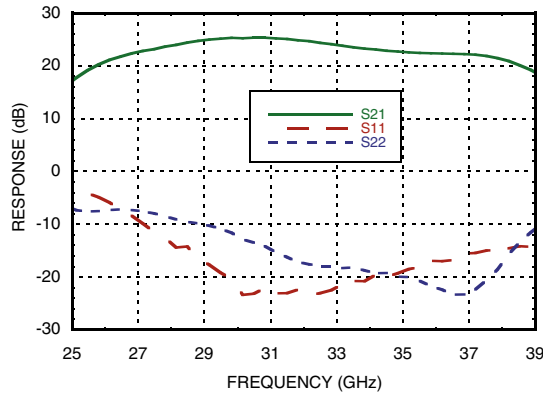

**Gain vs. Temperature**

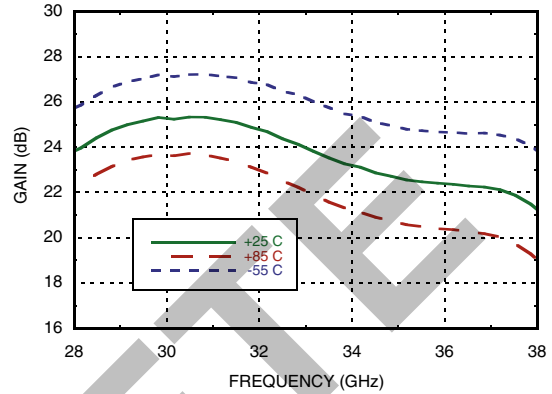

**Input Return Loss vs. Temperature**

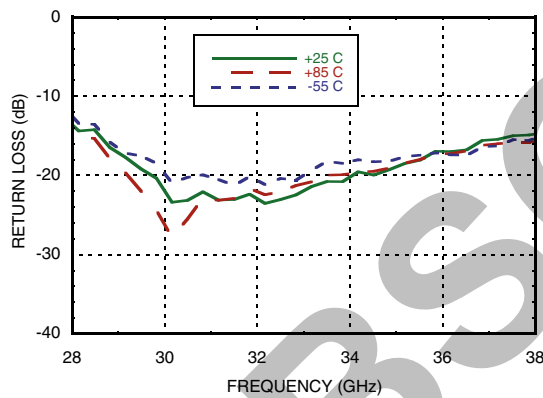

**Output Return Loss vs. Temperature**

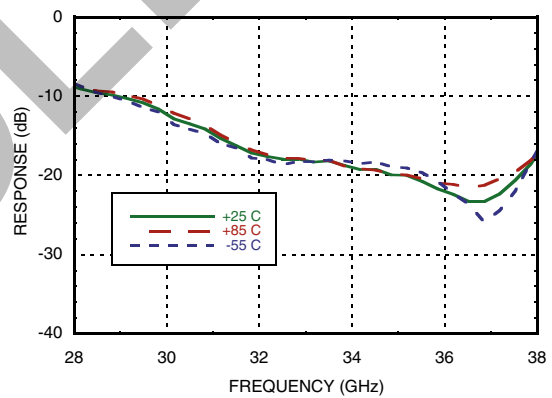

**P1dB vs. Temperature**

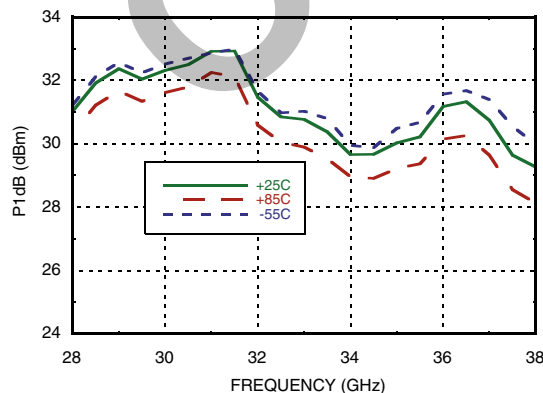

**P1dB vs. Supply Voltage**

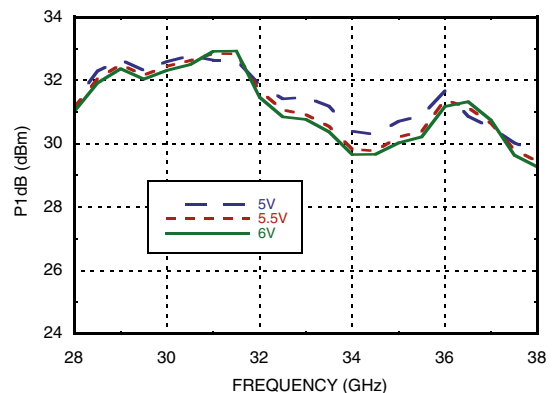

Information furnished by Analog Devices is believed to be accurate and reliable. However, no responsibility is assumed by Analog Devices for its use, nor for any infringements of patents or other rights of third parties that may result from its use. Specifications subject to change without notice. No license is granted by implication or otherwise under any patent or patent rights of Analog Devices. Trademarks and registered trademarks are the property of their respective owners.

For price, delivery, and to place orders: Analog Devices, Inc., One Technology Way, P.O. Box 9106, Norwood, MA 02062-9106 Phone: 781-329-4700 • Order online at [www.analog.com](http://www.analog.com) Application Support: Phone: 1-800-ANALOG-D

**GaAs pHEMT MMIC 2 WATT POWER AMPLIFIER  
29 - 37 GHz**



AMPLIFIERS - LINEAR & POWER - CHIP

**Psat vs. Temperature**

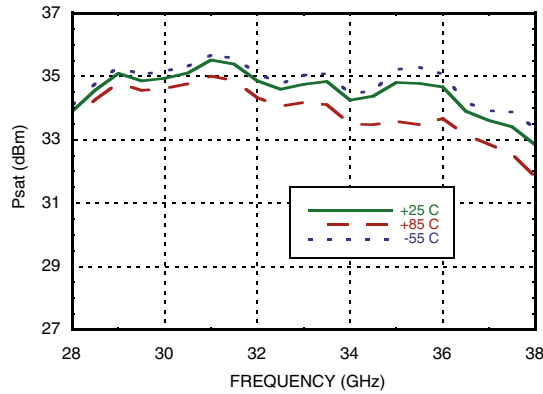

**Psat vs. Supply Voltage**

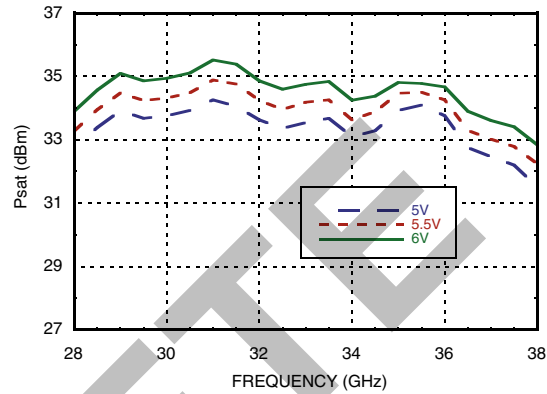

**P1dB vs. Supply Current (Idd)**

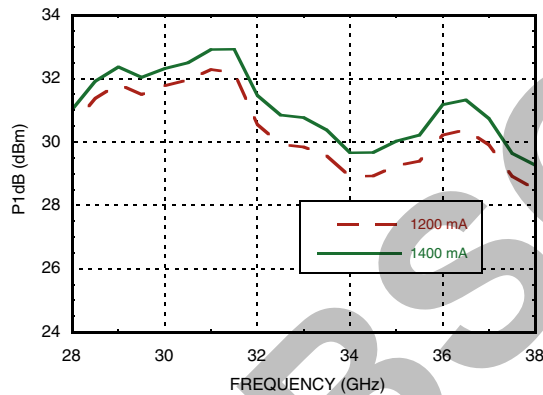

**Psat vs. Supply Current (Idd)**

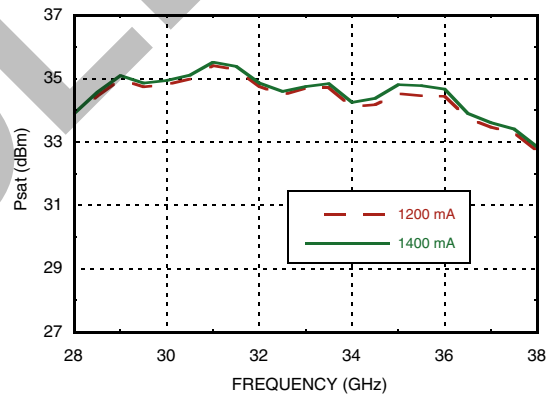

**Output IP3 vs. Temperature, Pout/Tone = +24 dBm**

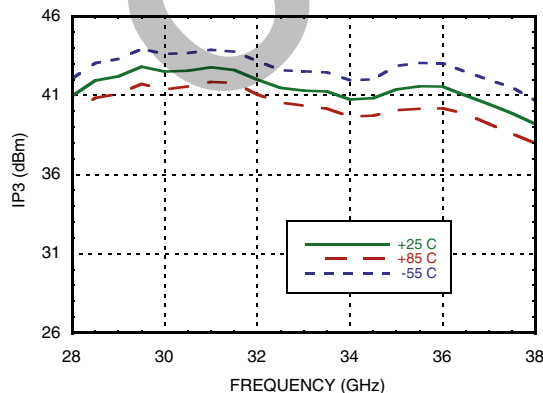

**Output IP3 vs. Supply Current, Pout/Tone = +24 dBm**

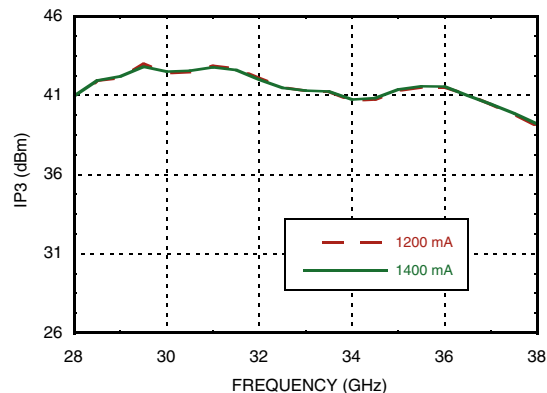

Information furnished by Analog Devices is believed to be accurate and reliable. However, no responsibility is assumed by Analog Devices for its use, nor for any infringements of patents or other rights of third parties that may result from its use. Specifications subject to change without notice. No license is granted by implication or otherwise under any patent or patent rights of Analog Devices. Trademarks and registered trademarks are the property of their respective owners.

For price, delivery, and to place orders: Analog Devices, Inc., One Technology Way, P.O. Box 9106, Norwood, MA 02062-9106 Phone: 781-329-4700 • Order online at [www.analog.com](http://www.analog.com) Application Support: Phone: 1-800-ANALOG-D

**GaAs pHEMT MMIC 2 WATT POWER AMPLIFIER  
29 - 37 GHz**



**Output IP3 vs. Supply Voltage, Pout/Tone = +24 dBm**

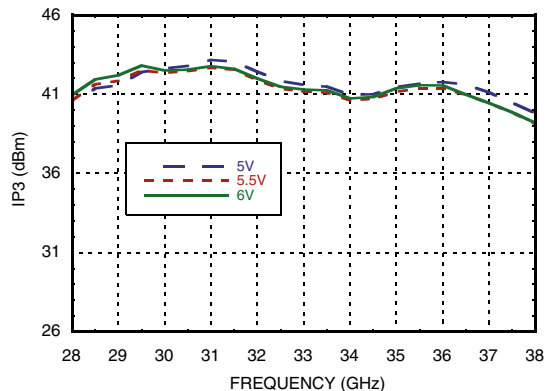

**Output IM3 @ Vdd = +5V**

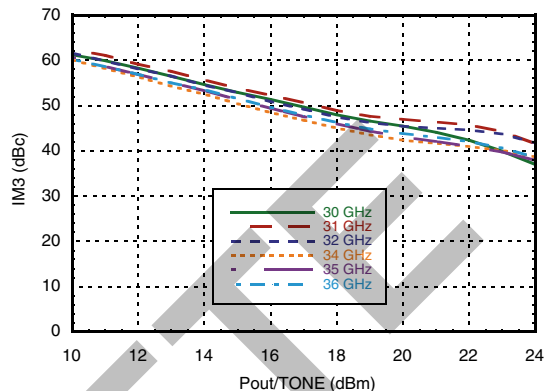

**Output IM3 @ Vdd = +5.5V**

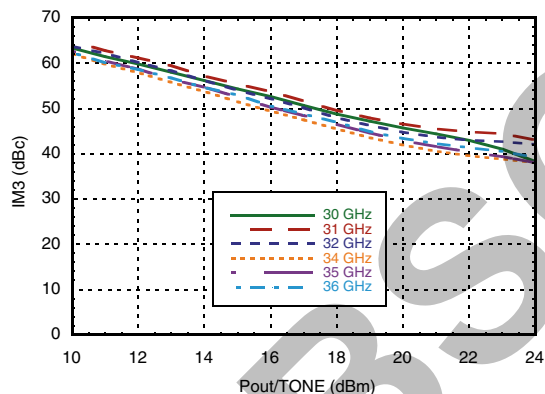

**Output IM3 @ Vdd = +6V**

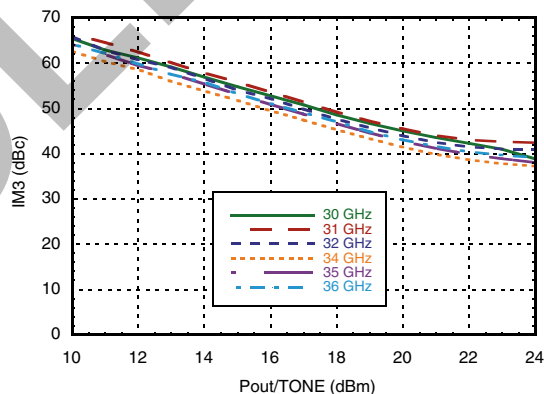

**Power Compression @ 30 GHz**

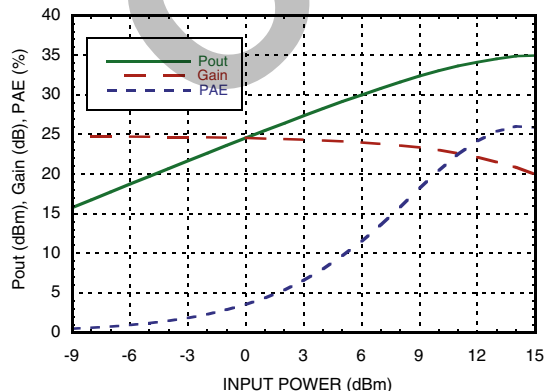

**Power Compression @ 33 GHz**

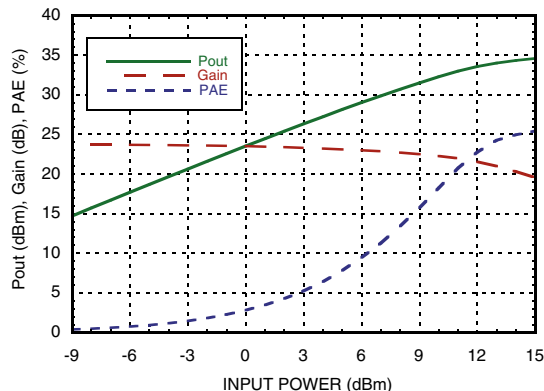

Information furnished by Analog Devices is believed to be accurate and reliable. However, no responsibility is assumed by Analog Devices for its use, nor for any infringements of patents or other rights of third parties that may result from its use. Specifications subject to change without notice. No license is granted by implication or otherwise under any patent or patent rights of Analog Devices. Trademarks and registered trademarks are the property of their respective owners.

For price, delivery, and to place orders: Analog Devices, Inc., One Technology Way, P.O. Box 9106, Norwood, MA 02062-9106 Phone: 781-329-4700 • Order online at [www.analog.com](http://www.analog.com) Application Support: Phone: 1-800-ANALOG-D

**GaAs pHEMT MMIC 2 WATT POWER AMPLIFIER  
29 - 37 GHz**



**Power Compression @ 36 GHz**

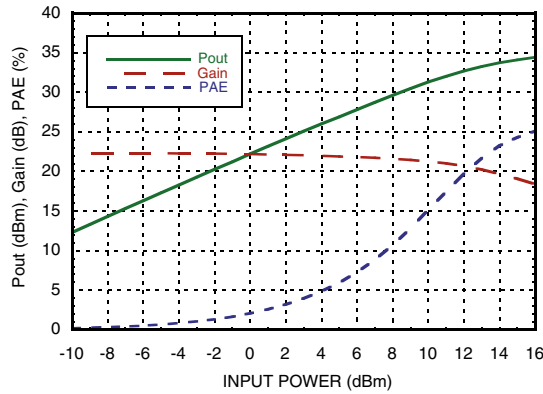

**Reverse Isolation vs. Temperature**

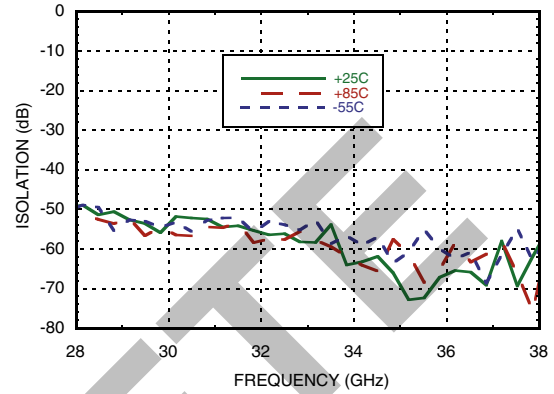

**Gain & Power vs. Supply Current @ 33 GHz**

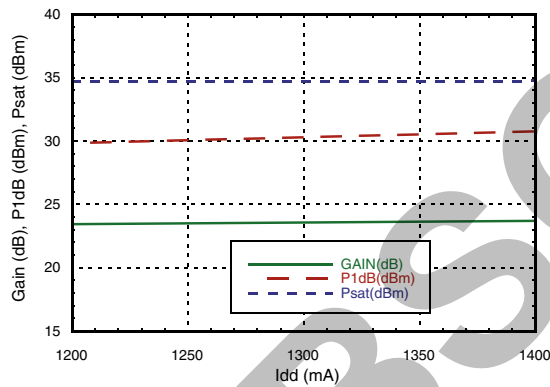

**Gain & Power vs. Supply Voltage @ 33 GHz**

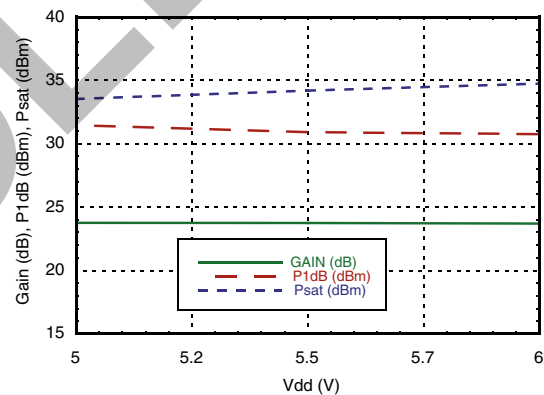

**Power Dissipation**

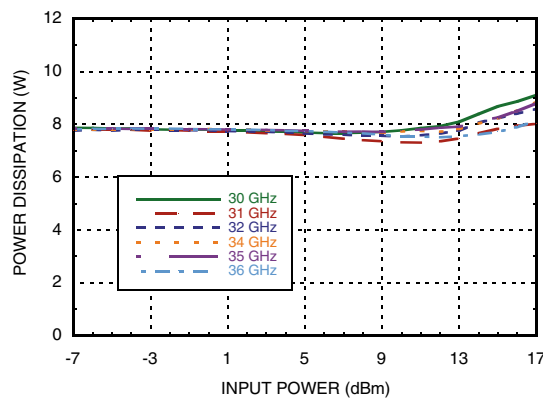

Information furnished by Analog Devices is believed to be accurate and reliable. However, no responsibility is assumed by Analog Devices for its use, nor for any infringements of patents or other rights of third parties that may result from its use. Specifications subject to change without notice. No license is granted by implication or otherwise under any patent or patent rights of Analog Devices. Trademarks and registered trademarks are the property of their respective owners.

For price, delivery, and to place orders: Analog Devices, Inc., One Technology Way, P.O. Box 9106, Norwood, MA 02062-9106  
Phone: 781-329-4700 • Order online at [www.analog.com](http://www.analog.com)  
Application Support: Phone: 1-800-ANALOG-D

## GaAs pHEMT MMIC 2 WATT POWER AMPLIFIER 29 - 37 GHz



### Absolute Maximum Ratings

Drain Bias Voltage (Vdd)	+7V
RF Input Power (RFIN)	+20 dBm
Channel Temperature	150 °C
Continuous Pdiss (T= 85 °C) (derate 135 mW/°C above 85 °C)	8.8 W
Thermal Resistance (channel to die bottom)	7.39 °C/W
Storage Temperature	-65 to +150 °C
Operating Temperature	-55 to +85 °C

### Typical Supply Current vs. Vdd

Vdd (V)	Idd (mA)
+5.0	1400
+6.0	1400

Note: Amplifier will operate over full voltage ranges shown above, Vgg adjusted to achieve Idd = 1400 mA at +6V



ELECTROSTATIC SENSITIVE DEVICE  
OBSERVE HANDLING PRECAUTIONS

### Outline Drawing

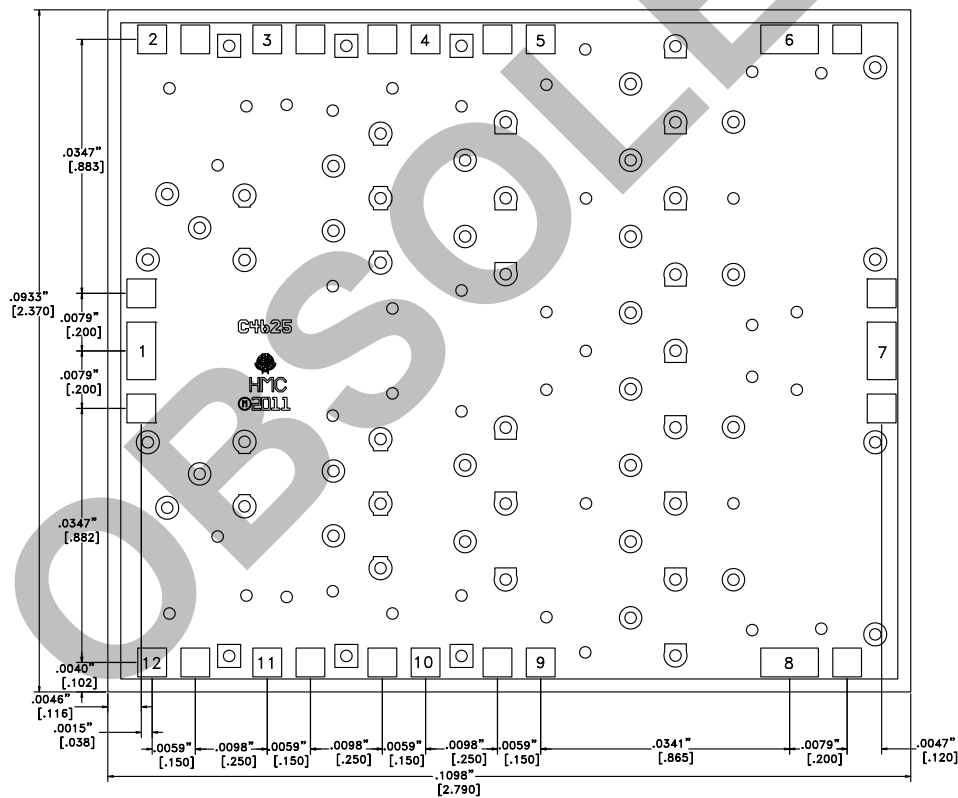

### Die Packaging Information <sup>[1]</sup>

Standard	Alternate
GP-1 (Gel Pack)	[2]

[1] Refer to the "Packaging Information" section for die packaging dimensions.

[2] For alternate packaging information contact Hittite Microwave Corporation.

#### NOTES:

- ALL DIMENSIONS ARE IN INCHES [MM]
- DIE THICKNESS IS .004"
- TYPICAL BOND PAD IS .004" SQUARE
- BACKSIDE METALLIZATION: GOLD
- BOND PAD METALLIZATION: GOLD
- BACKSIDE METAL IS GROUND.
- CONNECTION NOT REQUIRED FOR UNLABELED BOND PADS.
- OVERALL DIE SIZE ± .002

## GaAs pHEMT MMIC 2 WATT POWER AMPLIFIER 29 - 37 GHz



### Pin Descriptions

Pad Number	Function	Description	Interface Schematic
1	RFIN	RF signal input. This pin is AC coupled and matched to 50 Ohms over the operating frequency range.	
2, 12	Vgg1, Vgg2	Gate control for amplifier. Amplifier can be biased by either Vgg1 or Vgg2. External bypass capacitors of 100pF, 0.01uF, and 4.7uF are required.	
3, 4, 5, 6	Vdd1-4	Drain bias voltage for the top half of the amplifier. External bypass capacitors of 100pF required for each pin, followed by common 0.01uF and 4.7uF Capacitors.	
7	RFOUT	RF signal output. This pad is AC coupled and matched to 50 Ohms over the operating frequency range.	
8, 9, 10, 11	Vdd5-8	Drain bias voltage for the bottom half of the amplifier. External bypass capacitors of 100 pF required for each pin followed by common 0.01uF and 4.7uF capacitors.	
Die Bottom	GND	Die bottom must be connected to RF/DC ground.	

### Application Circuit

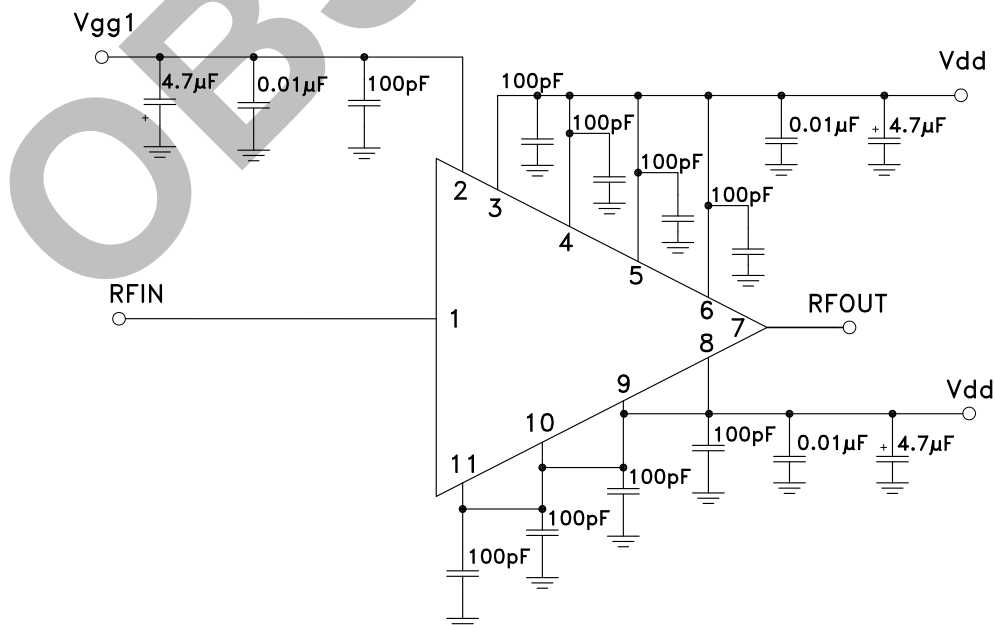

Information furnished by Analog Devices is believed to be accurate and reliable. However, no responsibility is assumed by Analog Devices for its use, nor for any infringements of patents or other rights of third parties that may result from its use. Specifications subject to change without notice. No license is granted by implication or otherwise under any patent or patent rights of Analog Devices. Trademarks and registered trademarks are the property of their respective owners.

For price, delivery, and to place orders: Analog Devices, Inc., One Technology Way, P.O. Box 9106, Norwood, MA 02062-9106 Phone: 781-329-4700 • Order online at [www.analog.com](http://www.analog.com) Application Support: Phone: 1-800-ANALOG-D

AMPLIFIERS - LINEAR & POWER - CHIP



**Assembly Diagram**

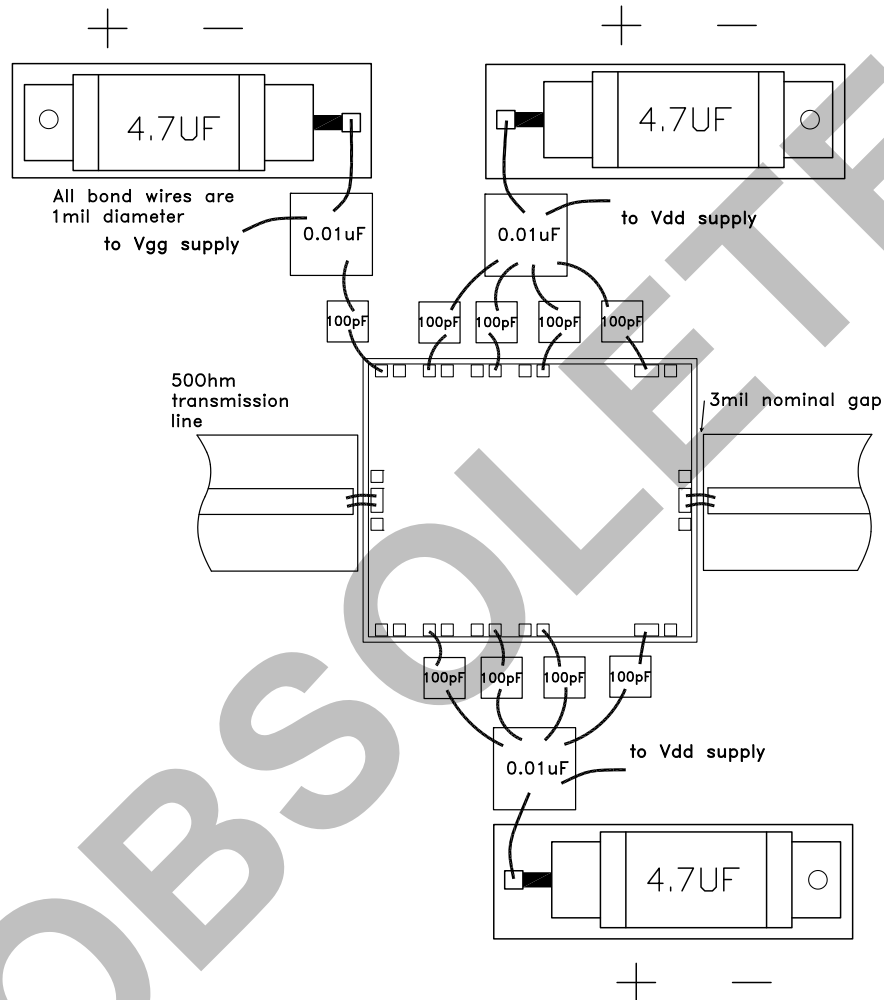



## GaAs pHEMT MMIC 2 WATT POWER AMPLIFIER 29 - 37 GHz



### Mounting & Bonding Techniques for Millimeterwave GaAs MMICs

The die should be attached directly to the ground plane eutectically or with conductive epoxy (see HMC general Handling, Mounting, Bonding Note).

50 Ohm Microstrip transmission lines on 0.127mm (5 mil) thick alumina thin film substrates are recommended for bringing RF to and from the chip (Figure 1). If 0.254mm (10 mil) thick alumina thin film substrates must be used, the die should be raised 0.150mm (6 mils) so that the surface of the die is coplanar with the surface of the substrate. One way to accomplish this is to attach the 0.102mm (4 mil) thick die to a 0.150mm (6 mil) thick molybdenum heat spreader (moly-tab) which is then attached to the ground plane (Figure 2).

Microstrip substrates should be located as close to the die as possible in order to minimize bond wire length. Typical die-to-substrate spacing is 0.076mm to 0.152 mm (3 to 6 mils).

#### Handling Precautions

Follow these precautions to avoid permanent damage.

**Storage:** All bare die are placed in either Waffle or Gel based ESD protective containers, and then sealed in an ESD protective bag for shipment. Once the sealed ESD protective bag has been opened, all die should be stored in a dry nitrogen environment.

**Cleanliness:** Handle the chips in a clean environment. DO NOT attempt to clean the chip using liquid cleaning systems.

**Static Sensitivity:** Follow ESD precautions to protect against > ± 250V ESD strikes.

**Transients:** Suppress instrument and bias supply transients while bias is applied. Use shielded signal and bias cables to minimize inductive pick-up.

**General Handling:** Handle the chip along the edges with a vacuum collet or with a sharp pair of bent tweezers. The surface of the chip may have fragile air bridges and should not be touched with vacuum collet, tweezers, or fingers.

#### Mounting

The chip is back-metallized and can be die mounted with AuSn eutectic preforms or with electrically conductive epoxy. The mounting surface should be clean and flat.

**Eutectic Die Attach:** A 80/20 gold tin preform is recommended with a work surface temperature of 255 °C and a tool temperature of 265 °C. When hot 90/10 nitrogen/hydrogen gas is applied, tool tip temperature should be 290 °C. DO NOT expose the chip to a temperature greater than 320 °C for more than 20 seconds. No more than 3 seconds of scrubbing should be required for attachment.

**Epoxy Die Attach:** Apply a minimum amount of epoxy to the mounting surface so that a thin epoxy fillet is observed around the perimeter of the chip once it is placed into position. Cure epoxy per the manufacturer's schedule.

#### Wire Bonding

Ball or wedge bond with 0.025mm (1 mil) diameter pure gold wire. Thermosonic wirebonding with a nominal stage temperature of 150 °C and a ball bonding force of 40 to 50 grams or wedge bonding force of 18 to 22 grams is recommended. Use the minimum level of ultrasonic energy to achieve reliable wirebonds. Wirebonds should be started on the chip and terminated on the package or substrate. All bonds should be as short as possible <0.31mm (12 mils).

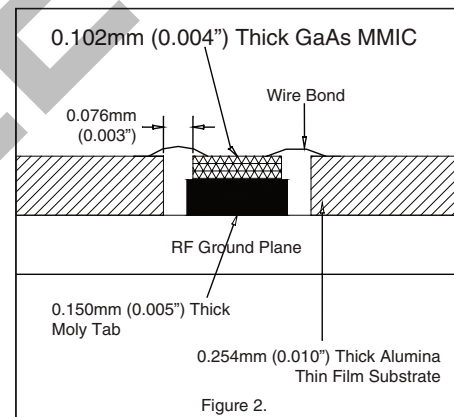
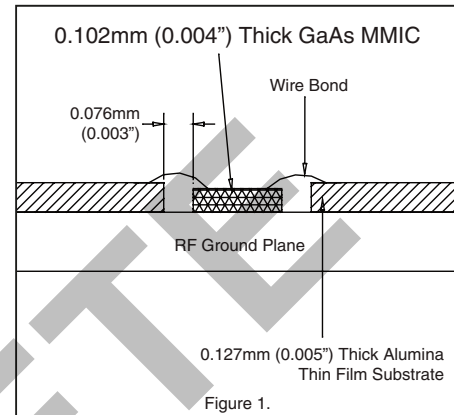

**Notes:**

OBSOLETE